

## Прихожая Домино / Furniture for a hall Domino

Код ТН ВЭД ЕАЭС

9403 60 100 1  
9403 90 300 0

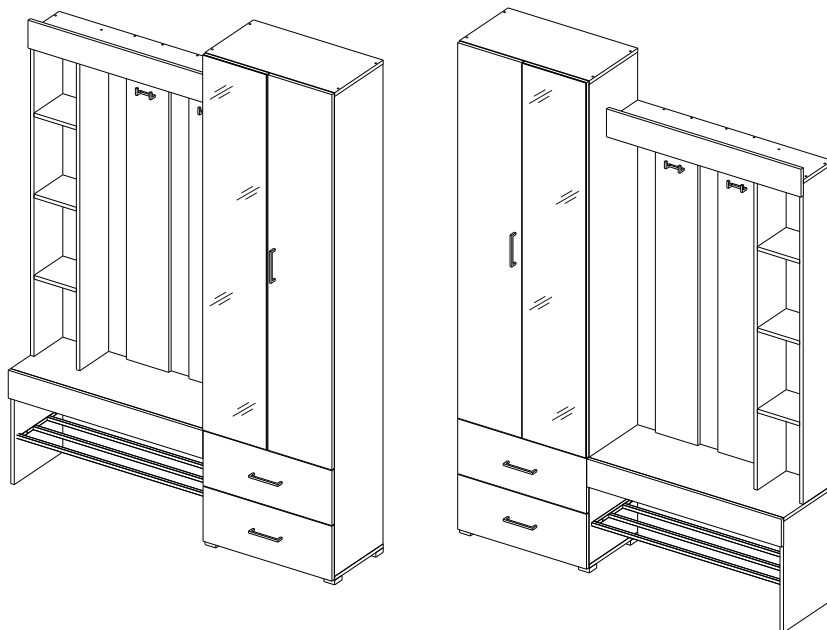

1500	2116	350

корпус - 34КДЗ / 2745

фасад  $\left\{ \begin{array}{l} 34ФДБ / 2746 \\ 34ФДП / 2748 \end{array} \right.$

Craft gold - Крафт золотой  
Concrete - Бетон  
White - Белый

### Комплектовочная ведомость / Set package sheet

Упак/ Package	Наименование	Description	Цвет детали/ Décor		Размер /Size, mm	Кол-во/ Quantity	№
			White	Concrete			
1	Боковина	Side	Craft gold		478x330	1	1
	Боковина левая	Side left			2064x330	1	3
	Боковина правая	Side right			2064x330	1	4
	Крыша	Top			600x330	2	5
	Крыша	Top			900x330	1	7
	Деталь ящика л	Side drawers L			134x300	2	13
	Деталь ящика пр	Side drawers R			134x300	2	14
	Полка мет	Shelves metal			-	1	-
2	Боковина	Side	Craft gold		1380x196	2	2
	Крыша	Top			900x196	1	6
	Вязка	Connecting element			196x196	3	8
	Тяги	Connecting element			100x883	1	12
	Задник	Back element			1380x196	2	10
3	Вязка	Connecting element	Craft gold		566x330	2	9
	Деталь ящика	Side drawers	Craft gold		134x507	4	15
	Фурнитура	Furniture/Cabinetry hardware	-	-	-	1	-

### Продается отдельно/Sold separately

1	Створка	Door	White	Concrete	1614x296	1	17
	Зеркало	Mirror	-		1605x287	1	21
	Створка	Door	White	Concrete	1614x296	1	17
	Тяги	Connecting element	Craft gold		120x900	2	11
	Панель ящика	Drawer panel	White	Concrete	236x596	2	16
	ХДФ	Back element	White		300x539	2	18
	ХДФ (клей)	Back element (glue)	White		467x298	2	19
	ХДФ (клей)	Back element (glue)	White		1624x298	2	20

(PL) Instrukcja montażu

(CZ) Návod k montáži

(D) Montageanleitung

(GB) Assembly instruction

(F) Model d'emploi

(HU) Szerelési útmutató

(I) Istruzione di montaggio

(NL) Handleiding voor de montage



(RU) Инструкция по монтажу

(RO) Instrucțiuni de montare

(SK) Návod k montáži

(TR) Montaj talimatı

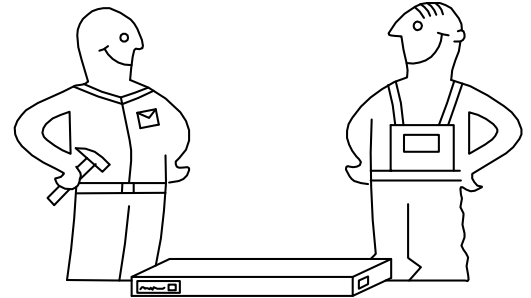
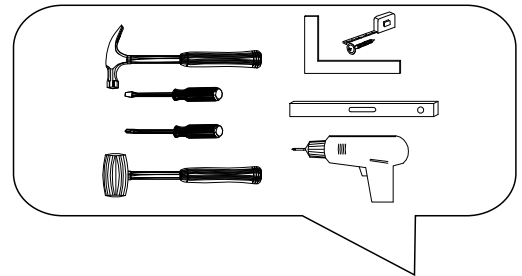



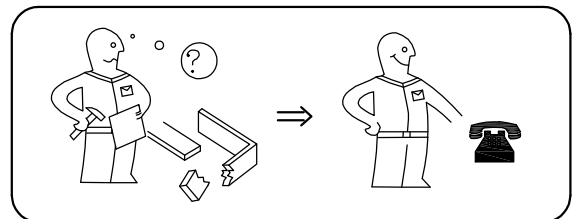
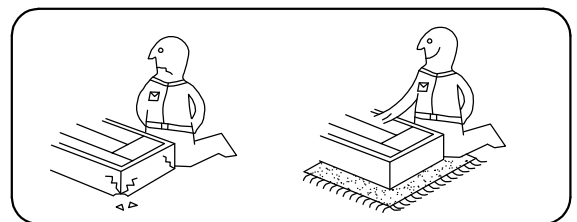



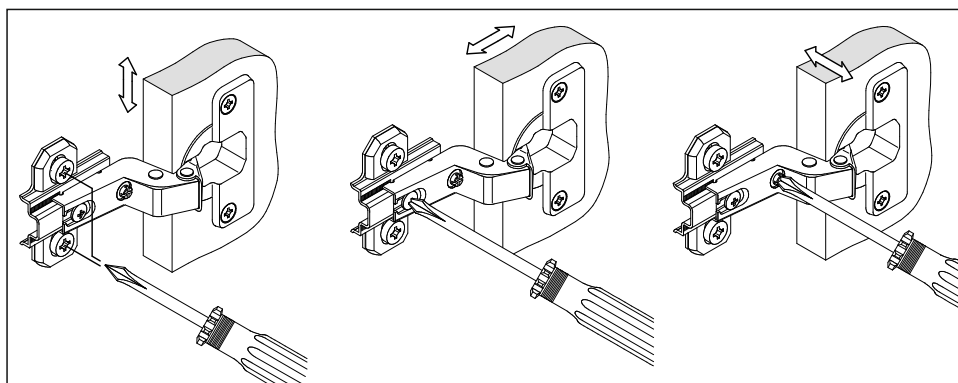
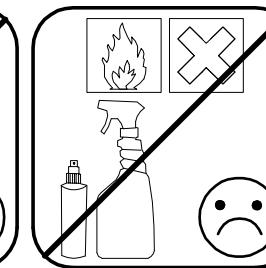
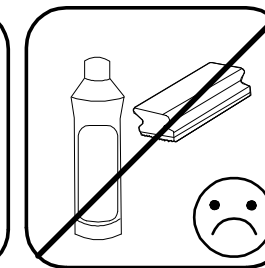
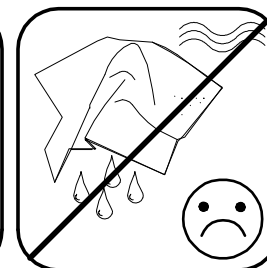
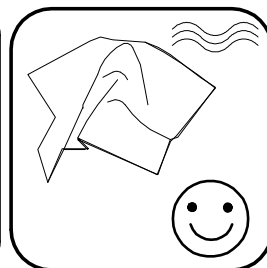
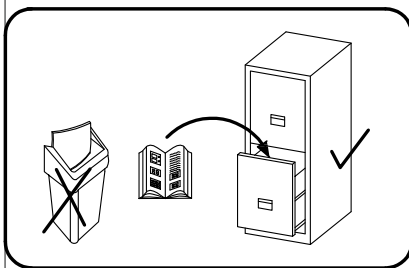

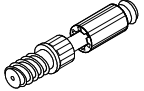

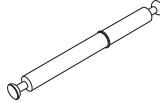
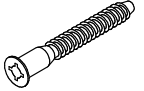

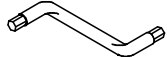
⚠ <b>Uwaga • Upozornění • Achtung • Attention • Caution • Figyelem</b> <b>Attenzione • Opgelet • Внимание • Atenție • Upozornenie • Dikkat</b> ⚠	
PL	Czyszczenie należy wykonać wyłącznie za pomocą ściereczki lub lekko nawilżonego ręcznika. Nie stosować środków czyszczących do szorowania.
CZ	Čistění je nutné vykonávat výhradně pomocí utěrky nebo lehce navlhčeného ručníku. Nepoužívejte čističí prostředky obsahující abrazivní částice.
D	Bitte nur mit einem Staubtuch oder leicht feuchtem Lappen reinigen. Keine scheuernden Putzmittel verwenden.
GB	Please only clean with a duster or a damp cloth. Do not use any abrasive cleaners.
F	Le nettoyage se fait uniquement à l'aide d'un torchon ou d'une serviette légèrement mouillée.
HU	A tisztítás kizárólag törülőruha vagy enyhén nedvesített törölköző segítségével végezhető. Súroló hatású tisztítószereket nem szabad használni.
I	Pulire esclusivamente con un panno o un asciugamano umido.
NL	Reinig alleen met een stofdoek of een lichtjes vochtige doek. Gebruik geen schurende poetsmiddelen.
RU	Очищайте от пыли тряпкой или слегка влажной ветошью. Не допускается применение чистящих средств, не предназначенных для ухода за мебелью.
RO	Curățarea trebuie efectuată numai cu o cârpă sau cu un prosop ușor umezit. Nu utilizați agenți de curățare abrazivi.
SK	Čistení je nutné vykonávať výhradne pomocí utierky alebo ľahko zvlhnutým ručníkom. Nepoužívajte čistiace prostriedky obsahujúce abrazívne častice.
TR	Lütfen sadece bir toz bezilye veya hafif nemli yumuşak bir bezle siliniz. Aşındırıcı temizlik malzemeleri kullanmayınız.

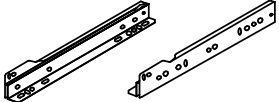
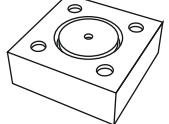
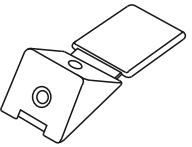
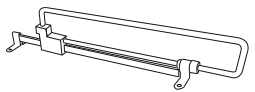
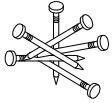

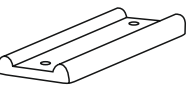
**Karta serwisowa • Servisní list • Service Karte • Service card • Carte de service • Szervizkártya**  
**Scheda di servizio • Service kaart • Сервисная карта • Fisa service • Servisný list • Servis karti**

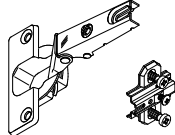

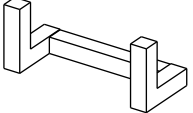
1		2		4		5	7x50	6	6,3x10,5
									
28 x		32 x		2 x		36 x		20 x	
14	3,5x30	15		18	3,5x15	22	300 mm	38	
									
4 x		1 x		70 x		2 x		4 x	
44		46	300 mm	48	2x20	72		73	
									
7 x		1 x		40 x		24 x		32 x	
76		77	mirror	91	Hinge A	83	2 m	88	B5 black
									
2 x		1 x		6 x		1 x		2 x	

126	C42 128 mm	129	
			
3 x		1 x	

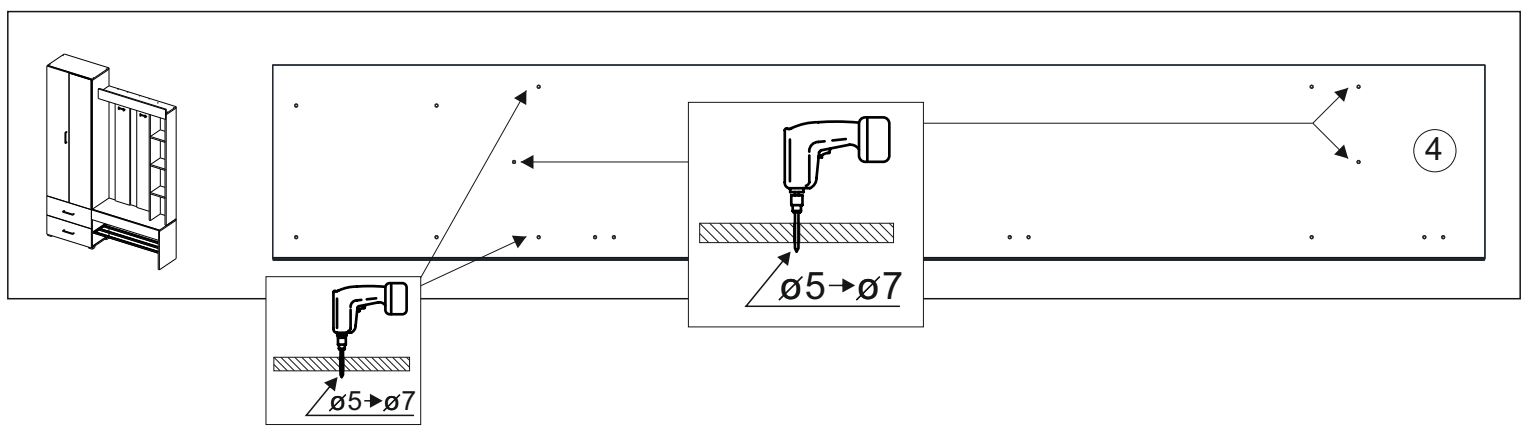
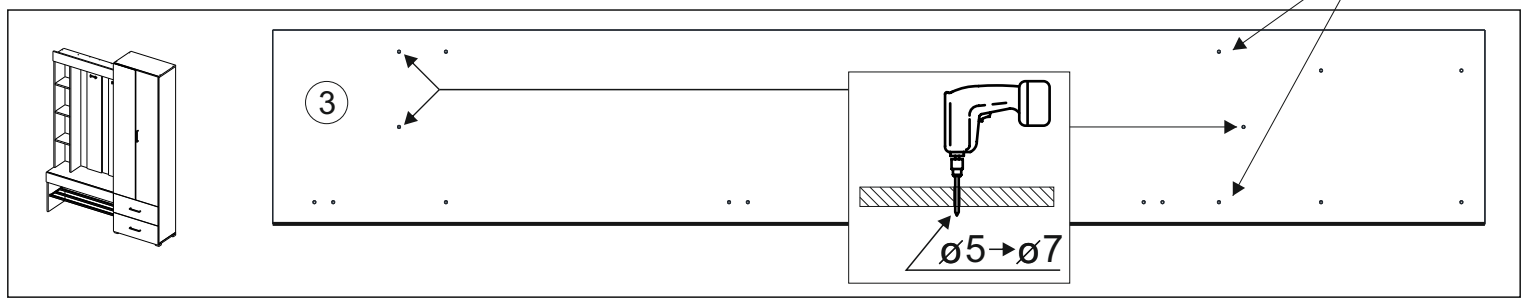
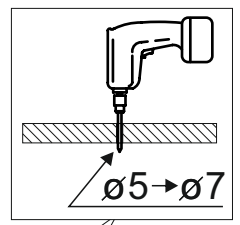

4

